

SPINODE MANUAL



Revision History

Revision	Date	Author(s)	Description
1	01/05/2025	JL	Initial version

Contents

1- Introduction	5
1.1 Compliance	5
1.2 Features	6
1.3 What's in the box	6
1.4 Saving data memory	6
1.5 Further help	7
2- Overview	8
3- Wiring	11
3.1 Power	11
3.2 Data	11
4- Web-Interface	15
4.1 Access	12
4.2 Home page	12
4.3 Testing page	14
4.4 Routing page	16
4.5 Pixels page	18
4.6 Settings page	21
4.7 About page	22
5- vManager	23
5.1 Backup	23
5.2 Upgrade Firmware	24
5.3 Blink	25
5.4 Factory default	25
5.5 Reboot	25
5.6 Installing vManager	25
Appendix A	27

©2025 Visual Productions B.V. All rights reserved.

No parts of this work may be reproduced in any form or by any means - graphic, electronic, or mechanical, including photocopying, recording, taping, or information storage and retrieval systems - without the written permission of the publisher.

While every precaution has been taken in the preparation of this document, the publisher and the author assume no responsibility for errors or omissions, or for damages resulting from the use of information contained in this document or from the use of programs and source code that may accompany it. In no event shall the publisher and the author be liable for any loss of profit or any other commercial damage caused or alleged to have been caused directly or indirectly by this document.

Due to the dynamic nature of product design, the information contained in this document is subject to change without notice. Revisions of this information or new editions may be issued to incorporate such changes.

Products that are referred to in this document may be either trademarks and/or registered trademarks of the respective owners. The publisher and the author make no claim to these trademarks.

Chapter 1

Introduction

Thank you for choosing the SpiNode. The SpiNode is a versatile node that will achieve data conversions between Art-Net, sACN and LED SPI protocols.

An internal web-server provides the web-interface through which you can setup the SpiNode. A modern browser is required to access this web-interface during set-up. A browser or computer is not required for stand-alone use after the initial set-up.

The Web-interface also includes a complete testing interface to help you easily identify universe boundaries, individual LED positions for an easy mapping and possible faulty LED

Additionally the SpiNode includes a 16 Universe extension license for the Visual Productions CueCore3.

At the time of writing this manual the SpiNode firmware was at version 1.00.



1.1 Compliance

This device is in compliance with the following regulations:

- CE
- UKCA

1.2 Features

The feature set of the SpiNode includes:

- 4 x synchronous or asynchronous SPI ports
- Up to 4096 pixels (1024 per port)
- 24 universes input (6 per port)
- More than 20 pixels protocols: WS2812, SK6812, WS2801, APA102 etc..
- Power through 20A system-wide (Only with DC input)
- 10/100 Mbs ethernet port
- Art-Net V.4 IN
- sACN E1.31 IN
- Web-based user-interface for programming
- Din-Rail format
- 16 universes extension license for CueCore3
- Power consumption 5-24V DC 500mA (not using power through)
- Power Supply: PoE class I or DC input
- Operating temperature -20C to +50C (-4F to 122F)
- Operating relative humidity 10% to 80% non-condensing

1.3 What's in the box

The SpiNode packaging contains the following items :

- SpiNode
- 1m network cable
- Info card

1.4 Saving data to memory

This manual will describe how to configure the SpiNode and set its internal routing. The unit's web-interface is used for editing these kinds of elements. When changes are made, these changes are directly stored in the RAM memory of the SpiNode and the programming will directly influence the behavior of the unit. RAM memory is, however, volatile and its content will be lost through a power cycle. For this reason the SpiNode will copy any changes in the RAM memory to its onboard flash memory. Flash memory retains its data even when not powered. The SpiNode will load all its data back from the flash memory upon startup.

This memory copy process is conducted automatically by the SpiNode and should not be of any concern of the user. One point of consideration is, however, that after making a change the unit should be given time to perform the copy to flash. As a rule of thumb, do not disconnect the power from the device within 10 seconds from making a programming change.

1.5 Further Help

If, after reading this manual, you have further questions, then please consult the online forum at <http://forum.visualproductions.nl> for more technical support.

Chapter 2

Overview

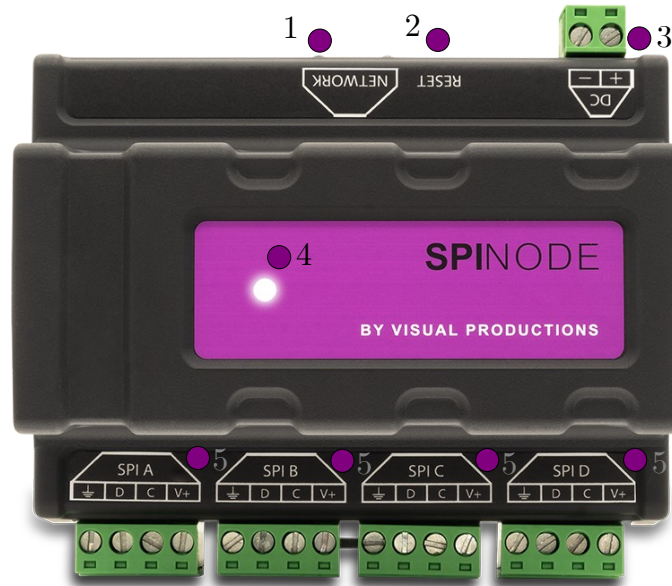

1- RJ45 Network Port

- 10/100 Mbit/s
- PoE Class I

Connection to your local network via standard network switch or directly to your computer or eDMX controller.

Can be used to power up the SpiNode using a PoE Class I compatible PoE switch or PoE injector.

When powered via PoE the SpiNode do not provide power on the SPI ports.

- **Green** LED: PoE power
- **Orange** LED: Network Activity

2- Reset button

- Short press on the reset button will switch the IP address mode of the SpiNode between static IP and DHCP.

- Do a long press (wait until the LED flashes white) to reset the IP address of the SpiNode to its default value 192.168.1.10.
- Holding down the reset button while turning on the SpiNode will do a factory default of the unit (release the button when the purple led stops flashing). All user data and programming will be erased and set to their default values, including IP settings.

3- Power Input

- If the SpiNode is not powered via PoE it can be powered via a DC power supply: Minimum 5V maximum 24V. The input is protected for inverted polarity, but will not start in case of inversion to protect potentially connected LED pixels.
- The power from the DC input can be distributed to the 4 SPI ports up to 10A per port.

The DC power input can be used together with the PoE power. In this case the SpiNode will be powered via PoE and the DC power supply will be used in case of PoE failure.

4- Status LED

When the SpiNode is in a normal state the LED will slowly pulse. The color of the LED will indicate the device status:

- **Red**: normal operating mode, DHCP
- **White**: normal operating mode, Static IP
- **Purple**: Hardware factory default (see “Reset button” p.8)
- **Cyan**: Installation of new firmware
- **Yellow/Orange**: Error, please contact your distributor

5- SPI Ports

The 4 galvanically isolated SPI ports provide power via their V+ and GND pins (up to 10A) and the DATA out and clock to directly connect your SPI pixels.

See below figure for the wiring of the terminal connector:



- GND: Reference for power and data
- D: Data signal, connect to the Data in of the LED pixel
- C: Clock signal for synchronous pixel protocols
- V+: Power out depending on SPINode power IN

Chapter 3

Wiring

3.1 Power

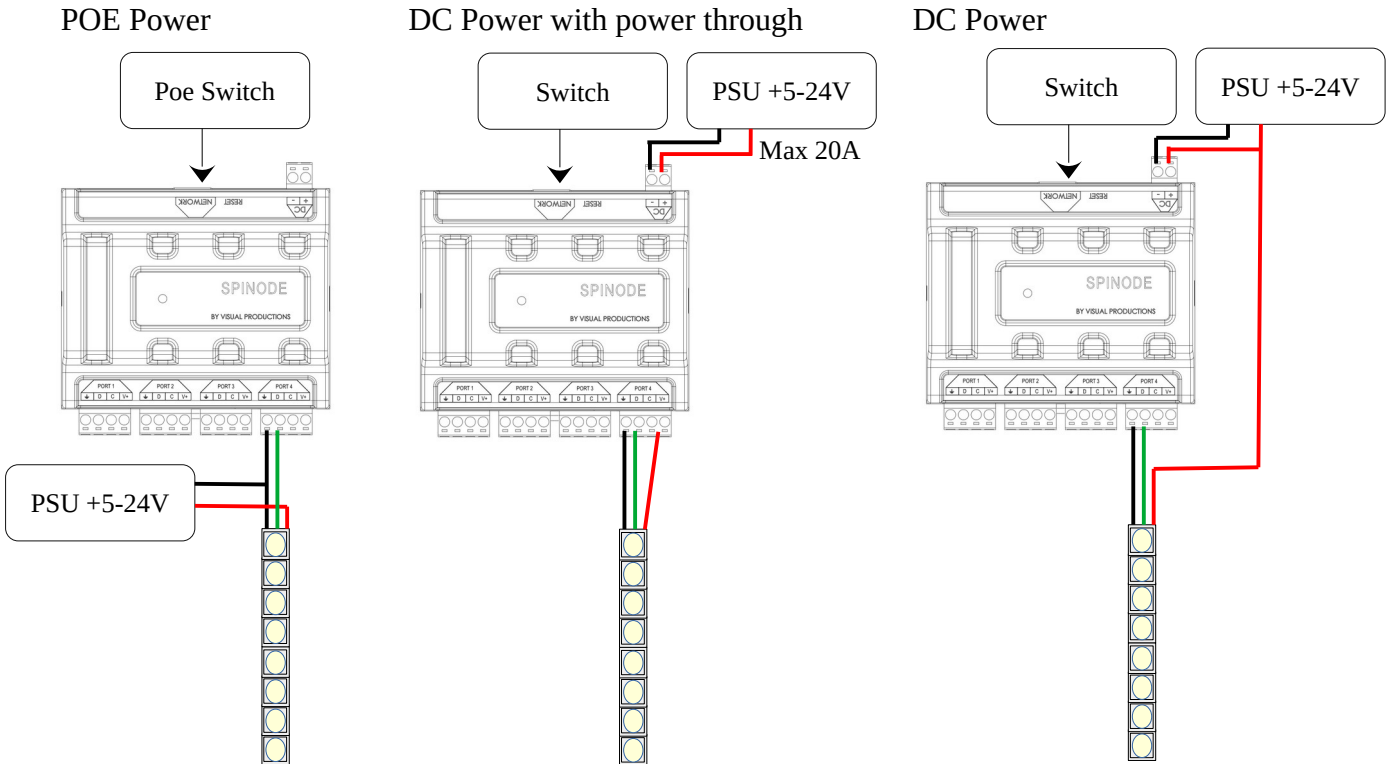

3.2 Data

The quality of the connection between the SpiNode and your first pixel will mainly depend on the quality of the cable you are using, the frequency/speed of the pixel driver and the electromagnetic environment.

For a reliable installation it is recommended to not have any connection between your SpiNode and your first pixel longer than 10m.

If your project requires a cable connection longer than 10 meters you can use your SPI extender which allows you to reach distances up to 250 meters using a standard Cat5 cable.

Chapter 4

Web-Interface

4.1 Access

There are 2 ways to access the SpiNode web interface:

- Directly type the IP address of the SpiNode in the address bar of your usual web-browser.
- Use the “browse” function of the vManager application (See “vManager” chapter p23)

Recommended web browser:

- Mozilla Firefox (v54 or higher)
- Google Chrome (v102 or higher)
- Apple Safari (v15 or higher)

4.2 Home Page

The “home” page provides global information about the SpiNode in a read only mode. This is the only page available, along with the “About” page, when password protection is activated.

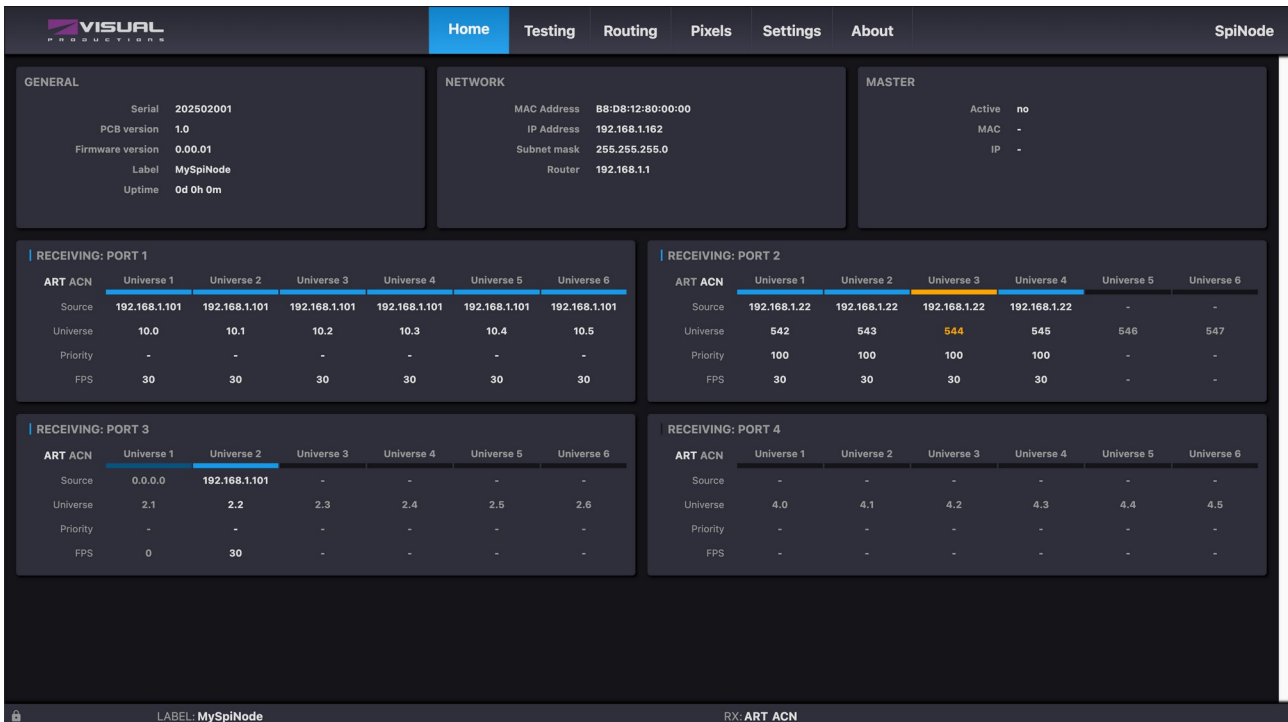

GENERAL: indicates general information about the SpiNode, like its serial number, the PCB version, the firmware version, the label associated with it and the uptime (time since the last reboot) of the unit.

NETWORK: indicates the network settings of the SpiNode. Those settings (except the MAC address) can be changed from the “Settings” page or via “vManager”.





MASTER: the SpiNode can be claimed by a CueCore3 to enable 16 additional universes for this specific CueCore3 unit.

The “Master” section indicates if the SpiNode is currently claimed by a CueCore3, and if so it will indicate the MAC and IP addresses of the claiming CueCore3.

The SpiNode can be claimed by only one CueCore3 unit at a time.

A CueCore3 cannot extend its number of universes over 32.

RECEIVING: Indicates informations about the input of each port. The blue indicator in front of the port number indicates if the port is activated (see “Routing page” p16).

- ART/ACN:
Indicates the expected protocol for the port
- Color segment:
 -  No data is expected for this universe
 -  Data is being received for this universe
 -  Data is expected for this universe but not received
 -  2 different sources are sending data for this universe
- Source:
Indicates the IP address or label of the controller sending the universes
- Universe:
Indicates the universe number expected
- Priority:
In case of sACN protocol indicates the priority value of the currently received universe
- FPS:
Indicates the frame rates of the received frames

4.3 Testing Page

The “Testing” page will allow you to easily test your wiring and settings by quickly selecting one or multiple pixels.

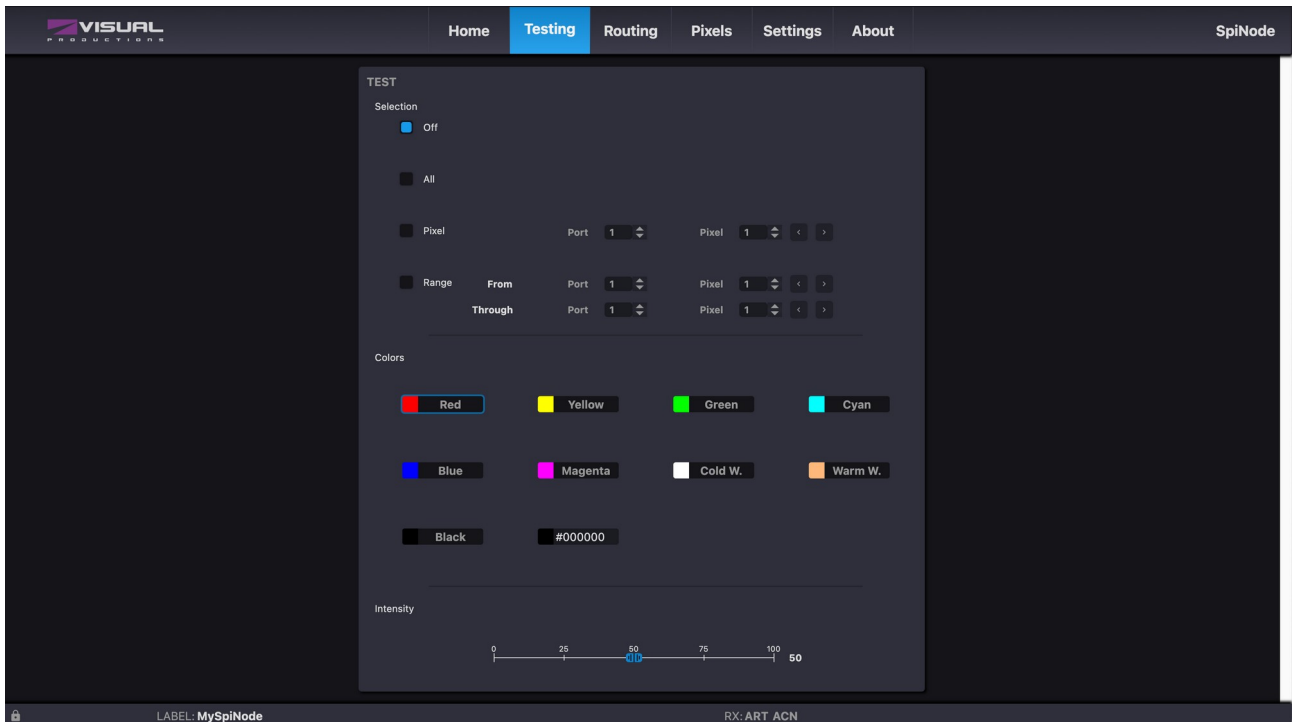

- Selection

- ◆ Off: Deactivate the testing mode and re-activate control from Art-Net or sACN.
- ◆ All: Testing color will be applied to all pixels of all ports.
- ◆ Pixels: Testing color will be applied to the specific pixel of the selected port.
- ◆ Range: Testing color will be applied to all the pixels between “start” pixel and “end” pixel (the range selection can go through multiple ports)

Hint: When using “Pixel” or “Range” selection you use the arrow keys of your keyboard to easily browse your pixels.

- Colors

Select the desired color from the 8 standard colors or use the custom color to use the specific desired color

- Intensity

Set the desired intensity of the test color. This setting will be applied on top of the master intensity of each port (see “Pixels page” p18)

4.4 Routing Page

The “Routing” page is the place where you will assign a specific protocol and universe to each port of the SpiNode.

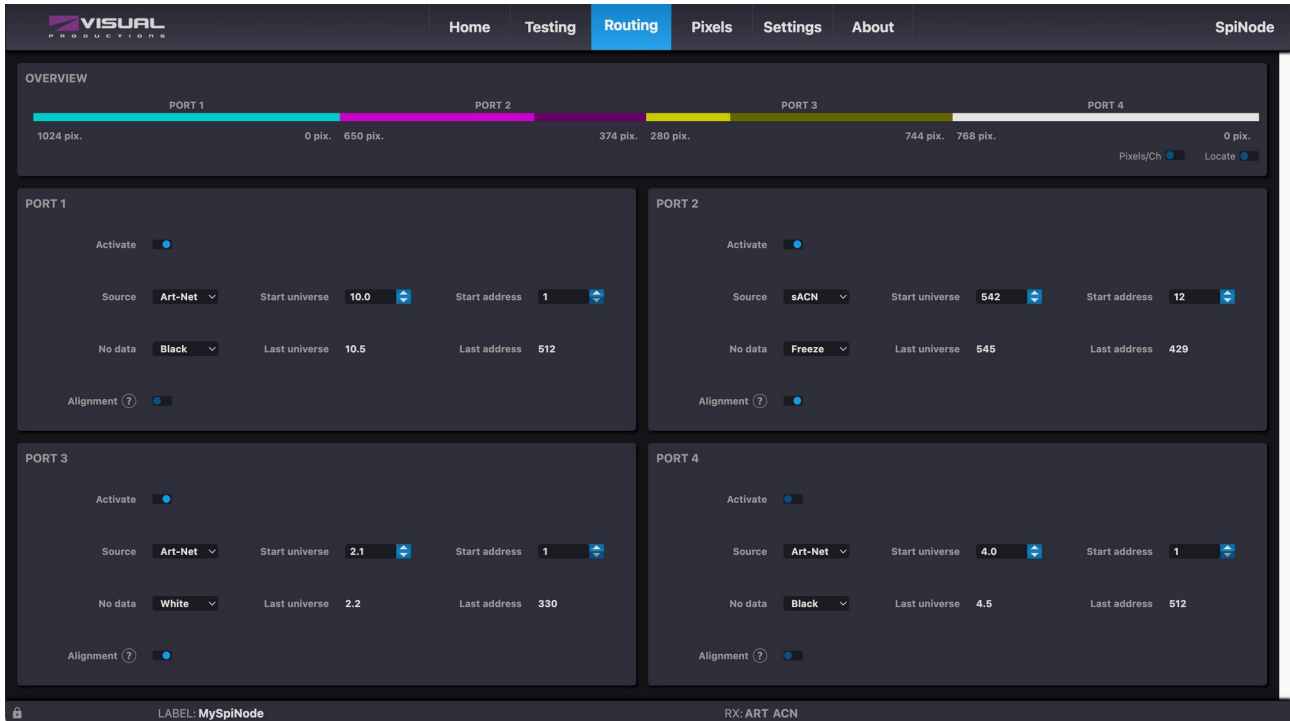

Overview (Also available in the “Pixels” page)

Gives you a visual feedback about the level of use of each port. Indicating the number of pixels or channels already used and the amount still available.

You can use the “Pixel/Ch” switch to display pixels or channel values.

The “Locate” function will automatically set each pixel to the color associated to the port they are connected to for an easy identification.

NOTE: The maximum output frame rate depends on the number of pixels assigned to a port. The more pixels the slower the frame rate will be.

When a port is set with its maximum number of pixels the output frame rate will be 30fps.

To avoid unsynchronized displays, all ports will be synced on the fps of the slowest port.

Ports

- **Activate:** Activate the reception of data for this port
- **Source:** Select the source protocol between Art-Net and sACN

- Start Universe: Select the first universe you want to assign to this port
- Start addresses: Select the first channel used in the selected universe
- No data: choose behavior of the port when the SpiNode stops receiving control data. You can choose between:

Black: all pixels are turned off

White: all colors of each pixel will go full

Freeze: the pixels will keep displaying the last frame received

- Last universes: Depending on the start universe, address and the number and type of pixels the SpiNode will calculate and display the universe used by the latest pixel connected to the port.
- Last address: Indicates the last channel used by the last pixel connected to the port.
- Alignment: Some pixel controllers or softwares do not patch pixels/fixtures over 2 different universes. When “alignment” is activated the SpiNode assumes that no pixels are patched across 2 universes. In this mode the maximum number of RGB pixels per port is limited to 1020.

When deactivated, all channels of each universe will be used.

Alignment Activated:

Universe	1					2			
Channel	508	509	510	511	512	01	02	03	04
Pixel	1			/	/	2			3
Color	Red	Green	Blue	/	/	Red	Green	Blue	Red

Alignment Deactivated:

Universe	1					2			
Channel	508	509	510	511	512	01	02	03	04
Pixel	1			2			3		
Color	Red	Green	Blue	Red	Green	Blue	Red	Green	Blue

- Warning

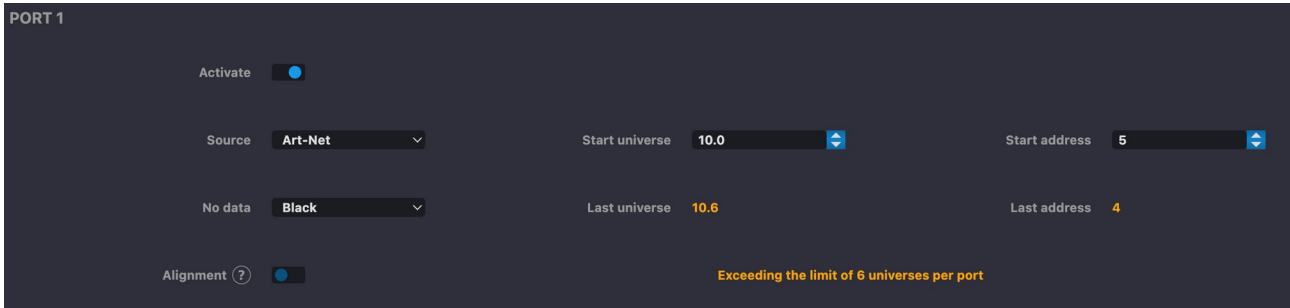

The SpiNode can receive up to 6 universes per port. However, if you patch the maximum number of pixels on one port and do not use 1 as a start address, you will need to receive 7 different universes.

In this case an error message will appear indicating that you exceed the limit of 6 universes.

4.5 Pixels Page

The “Pixels” page allows you to select for each port the pixel protocol you want to use and various color settings.



Overview (Also available in the “Routing” page)

Gives you a visual feedback about the level of use of each port. Indicating the number of pixels or channels already used and the amount still available.

1. You can use the “Pixel/Ch” switch to display pixels or channel’s values.

The “Locate” function will automatically set each pixel to the color associated to the port they are connected to for an easy identification.

Ports

- Chip: Select the type of pixel protocol you want to use for each specific port

See Appendix A for the list of available pixel protocols.

- Frequency: Depending on the pixel protocol, the transmission speed can be adjusted. Note that a higher speed can have effects on the maximum length of the connection.

- Personality: Type or use the “personality wizard” to indicate the order of the colors in the pixel connected to the port.

Available colors are:

Red	Green	Blue	Cold White	Warm White
R	G	B	C	W

Example:

If the order is Green, then Red, then Blue type GRB

If the order is Red, then Green, then Blue, then Cold White type RGBC

- Personality wizard: This tool will help you know what the color order of your pixel is. Open it by clicking on the Magic wand button close to the personality input.

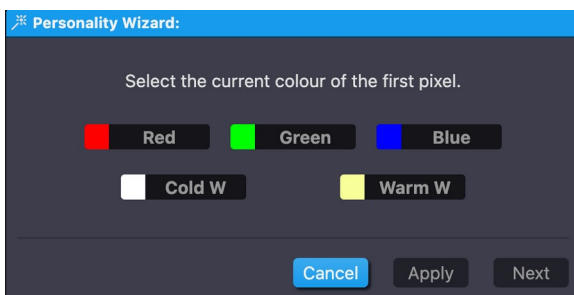

Once open, the wizard will turn on the first color of your first pixel.

Select the currently displayed color and press next.



Repeat until, the first color of the second pixel turns on.

Then click “Apply”, to apply the corresponding color order and close the wizard.

- No. of pixels: type in the number of pixels connected to the specific port. The maximum number of pixel depends on the number of colors in the pixels.

Number of colors	1	2	3	4	5
Max Number of Pixels	1024	1024	1024	768	614

- Master: Set the maximum intensity that will be applied to all pixels connected to the port.
- Maximum: Set the value used as maximum for each color.
- Gamma: Set the gamma correction for each color.

Gamma correction extend the use of the lower values of the intensity dynamic range, improving the visibility of intensity variations for the human eye.

Recommended value is between 1 and 2.

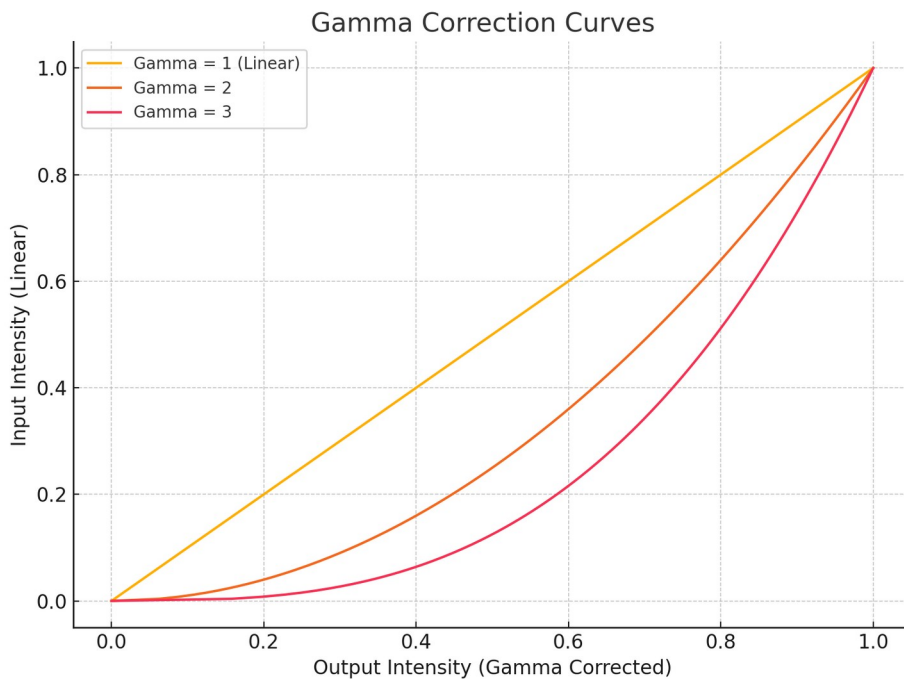

Note: Using the “Master”, “Maximum” and “Gamma” settings will reduce the dynamic range of intensity, potentially making intensity fading less smooth.

4.6 Settings Page

The “Settings” page allows you to modify various parameters and behaviors of the SpiNode.

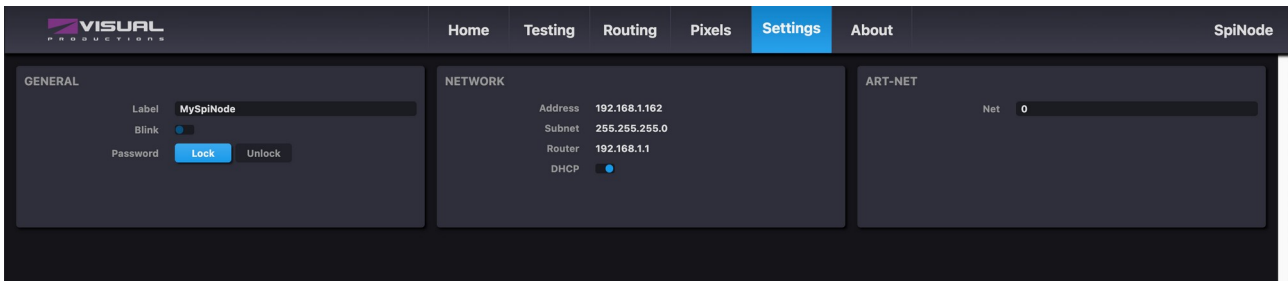

GENERAL

- **Label:** Custom name you can give to your SpiNode for an easy identification. The label will be displayed in the home page, in the Webpage title of the web-interface and in vManager. The length of a label is limited to 32 characters.
- **Blink:** Will activate blinking on the status LED of the SpiNode for identifying the particular unit amongst multiple devices.
- **Password:** You can activate or deactivate a password protection to protect the data/programming of the SpiNode. When password protection is activated it is not possible to modify any settings of the SpiNode but the pages are still accessible and visible.

To remove the password protection in case of a lost password do a long press on the “Reset” button until the status LED blinks white. This will also set the SpiNode to its default IP settings. (See “Reset Button” section p.8)

Network

Indicates the IP settings of the SpiNode: IP address, subnet mask, and router/gateway IP address.

The SpiNode can be set in Static IP mode or in DHCP depending on the position of the DHCP switch button.

By changing the position of the DHCP switch you will automatically change the IP address of the SpiNode and loose the connection to it.

When going from DHCP mode to static IP mode, you will be requested to provide the new IP settings.

If you activate the DHCP mode without a DHCP server in your local network, the SpiNode will automatically set itself with a IP address in the range 169.254.xx.xx after a timeout.

Art-Net

The “Net” parameter allows you to change the net number the node will be using to receive and send Art-Net messages. The “Net” can be set between 0 and 127.

4.7 About Page

The “About” page gives various information about the SpiNode itself, but also about official Visual Productions support channels, development credits and legal protection.

The screenshot displays the 'About' page of the SpiNode web interface. The page has a dark theme with a navigation bar at the top containing 'Home', 'Testing', 'Routing', 'Pixels', 'Settings', and 'About' (which is highlighted in blue). The 'SpiNode' label is visible in the top right corner. The main content area is divided into three columns: 'SYSTEM INFORMATION', 'SUPPORT', and 'CREDITS'. Below these columns is a 'LEGAL' section.

SYSTEM INFORMATION	SUPPORT	CREDITS
Serial: 202502001	Forum: www.visualproductions.nl/forum	Software: Bart Wijlens
PCB version: 1.0	User manual: www.visualproductions.nl/download	Software: Guido Visser
MAC address: BB:DB:12:80:00:00		Electronics: Alexandar Ninov
Firmware version: 0.00.01:00004993		UX: Julien Levaufre

LEGAL

© Copyright 2025
Visual Productions BV
Haarlem, The Netherlands

Warning: This computer program is protected by copyright law and international treaties. Unauthorized reproduction or distribution of this program, or any portions of it, is prohibited.

Chapter 5

vManager

A free-of-charge software tool called vManager has been developed to manage the devices. vManager allows for:

- Setup the IP address, subnet mask, router and DHCP
- Backup and restore the device's internal data and settings
- Perform firmware upgrades
- Identify a specific device (in a multi device set-up) by blinking its LED
- Revert to factory defaults

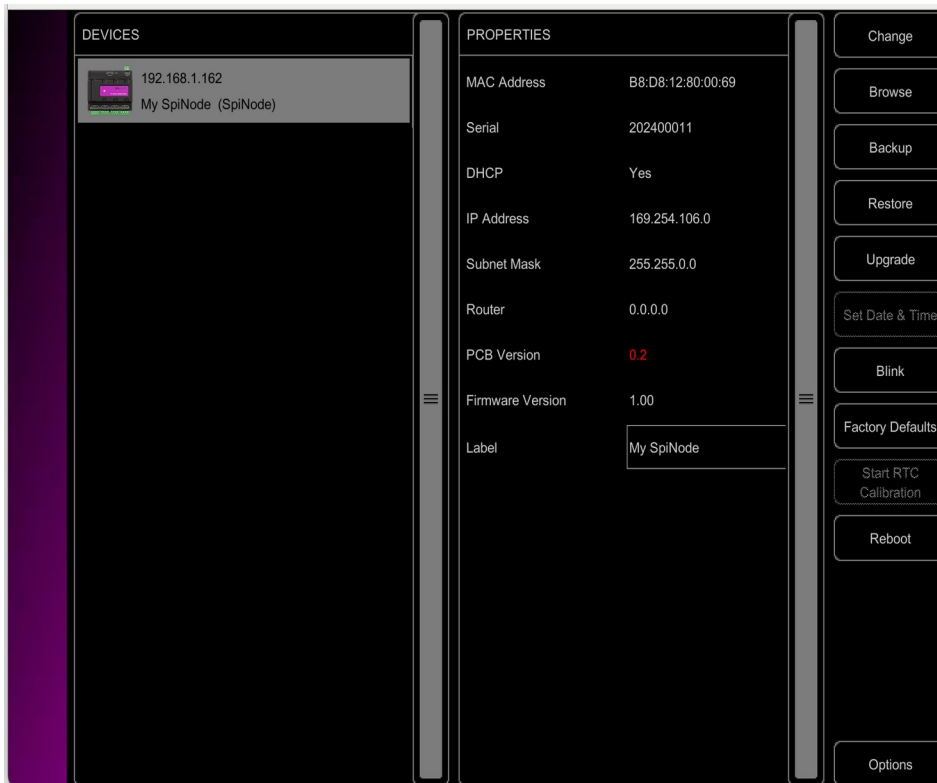

5.1 Backup

Backups of all the programming data inside the device can be made. This backup file (a *.tar archive) is saved on the computer's hard-disk and can be easily transferred via e-mail or USB stick. The data of the backup can be restored via the Restore button.

Apps distributed by app stores are not allowed to access files outside this designated location. It is important to know where vManager is storing its files, in case you wish to transfer a backup file to memory stick or dropbox.

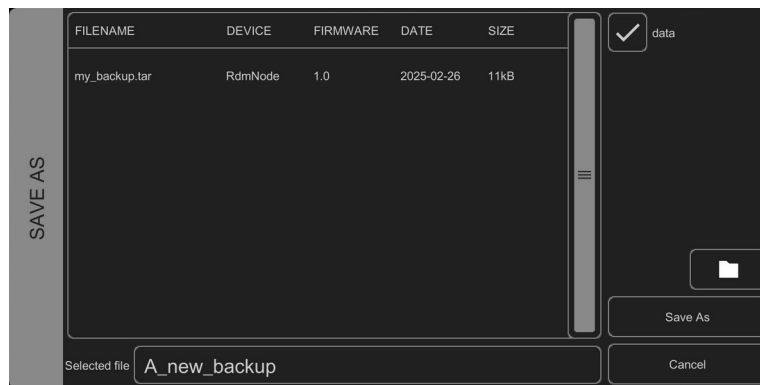

The designated file location differs per operating system and is likely to be a long and obscure path. For this reason, vManager provides you with a shortcut to the correct file location. A Folder button can be found in the file related dialogs. Clicking this button will open a file browser at the appropriate folder.

5.2 Upgrade Firmware

To upgrade the firmware, first select the device and press the Upgrade Firmware button. The dialog allows for selecting from the list of firmware versions available.



Warning: Make sure the power to the device is not interrupted during the upgrade process.

5.3 Blink

The device's LED can be set to Blink fast for identifying the particular unit amongst multiple devices. The blinking is enabled by double-clicking on a device in the Devices list or by selecting a device and then clicking the Blink button.

5.4 Factory Defaults

All the user data like settings and routing design are stored in the on-board flash memory. They will be completely erased and all settings will be reverted to their defaults by pressing the Factory Defaults button. This action does not affect the device's IP settings.

5.5 Reboot

The Reboot button allows you to remotely restart the device. This is useful for testing the unit behavior after a power-cycle.

5.6 Installing vManager

The vManager app is available on a wide range of operating systems, both mobile and desktop.

The software is distributed through app-stores to take advantage of receiving future software updates automatically.

5.6.3 Windows

Visit the Microsoft store at:

<https://apps.microsoft.com/detail/9nblggh4s758?hl=en-US&gl=US>

Windows 10 is required.

5.6.4 macOS

Visit the Apple macOS app store at:

<https://apps.apple.com/us/app/vmanager/id1074004019>

macOS 11.3 is recommended.

5.6.5 Ubuntu

You can acquire the vManager from Snapcraft at <https://snapcraft.io/vManager>.

Alternatively, it can be installed by using the command-line:

```
snap find vManager  
snap install vManager
```

To update the apps later on via the command-line type:

```
snap refresh vManager
```

Ubuntu 22.04 LTS is recommended. The software is only available for the amd64 architecture.

Appendix A

List of available Pixel protocols

Protocol	Clocked	Frequencies
APA102	✓	400 KHz 800 KHz 1 MHz
APA107	✓	400 KHz 800 KHz 1 MHz
HD107S	✓	400 KHz 800 KHz 1 MHz
HD108	✓	400 KHz 800 KHz 1 MHz
LC8823	✓	400 KHz 800 KHz 1 MHz
NS108	✓	400 KHz 800 KHz 1 MHz
SK6812		Default
SK6813		Default
SK9822	✓	400 KHz 800 KHz 1 MHz
SK9826	✓	400 KHz 800 KHz 1 MHz
TM1804		400 KHz 800 KHz
TM1809		555 KHz 1100 KHz
TM1812		Default
UCS1903		400 KHz 800 KHz
UCS2903		Default
UCS2904		Default
WS2801	✓	400 KHz 800 KHz 1 MHz
WS2803	✓	400 KHz 800 KHz 1 MHz
WS2811		400 KHz 800 KHz
WS2812		Default
WS2813		Default
WS2814		Default
WS2815		Default